

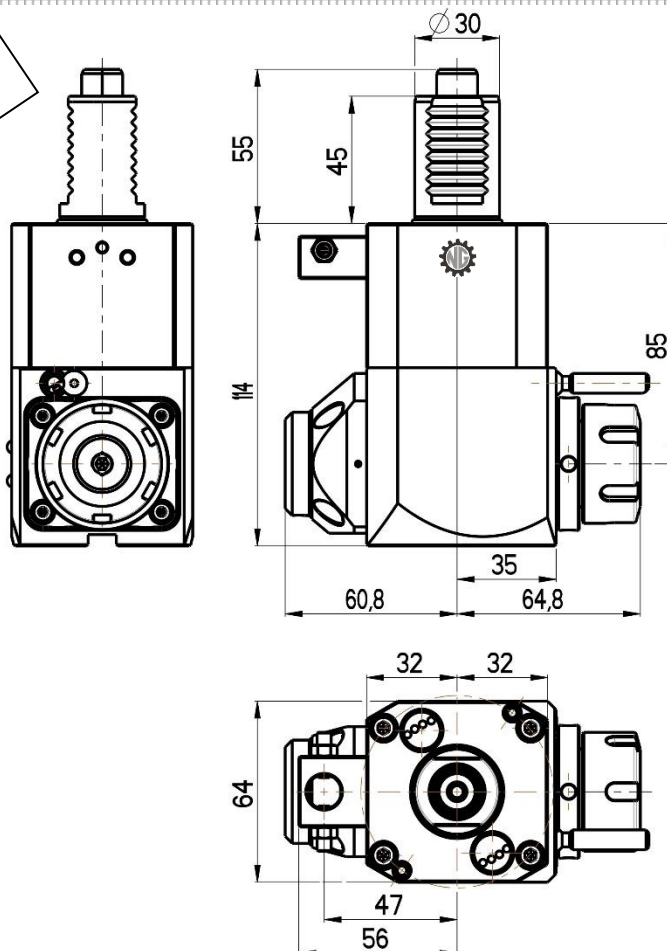

# ANGULAR LIVE TOOL HOLDER

VDI 30 / DIN 5482

Product code:  
**NGT1-30/211-25/3.3-85**



**Max. speed:** 6000 rpm

**Max. torque:** 28 Nm

**Collet:** ER25

**Direction of rotation:** ↻ ↺

**Ratio:** 1:1

**Cooling:** external & internal

**Max. pressure:** 80 bar

### Optional accessories

**Nut :** Clamping wrench type E 25



**Spindle:** Hook wrench DIN 1810B 45-50