



ANGULAR LIVE TOOL HOLDER

EMAG TURRET

BMT 55-100

Product code:

NGT2-55/201-25/3.3-85(EM2)

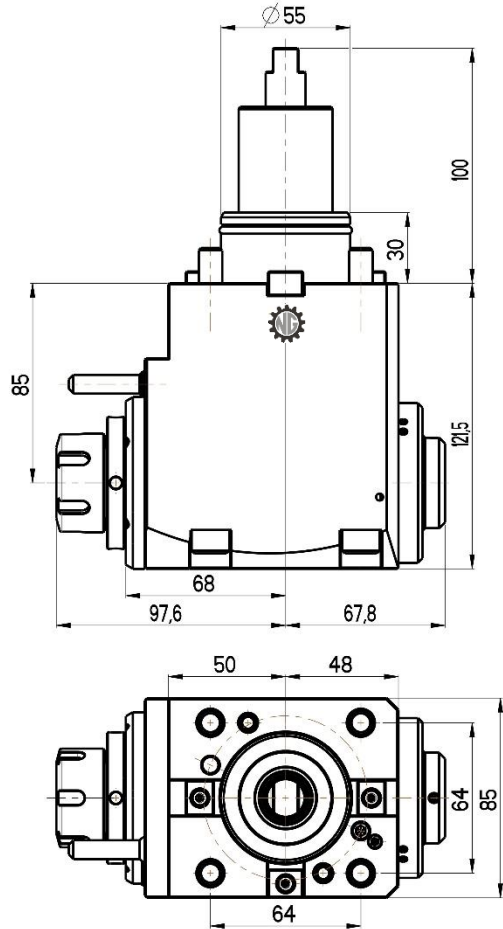
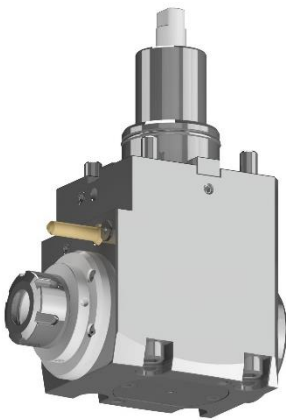

Max. speed: 6000 rpm

Max. torque: 50 Nm

Collet: ER25

Direction of rotation:

Ratio: 1:1

Cooling: external & internal

Max. pressure: 80 bar

Optional accessories

Nut : Clamping wrench type E 25



Spindle: Hook wrench DIN 1810B 52-55

