

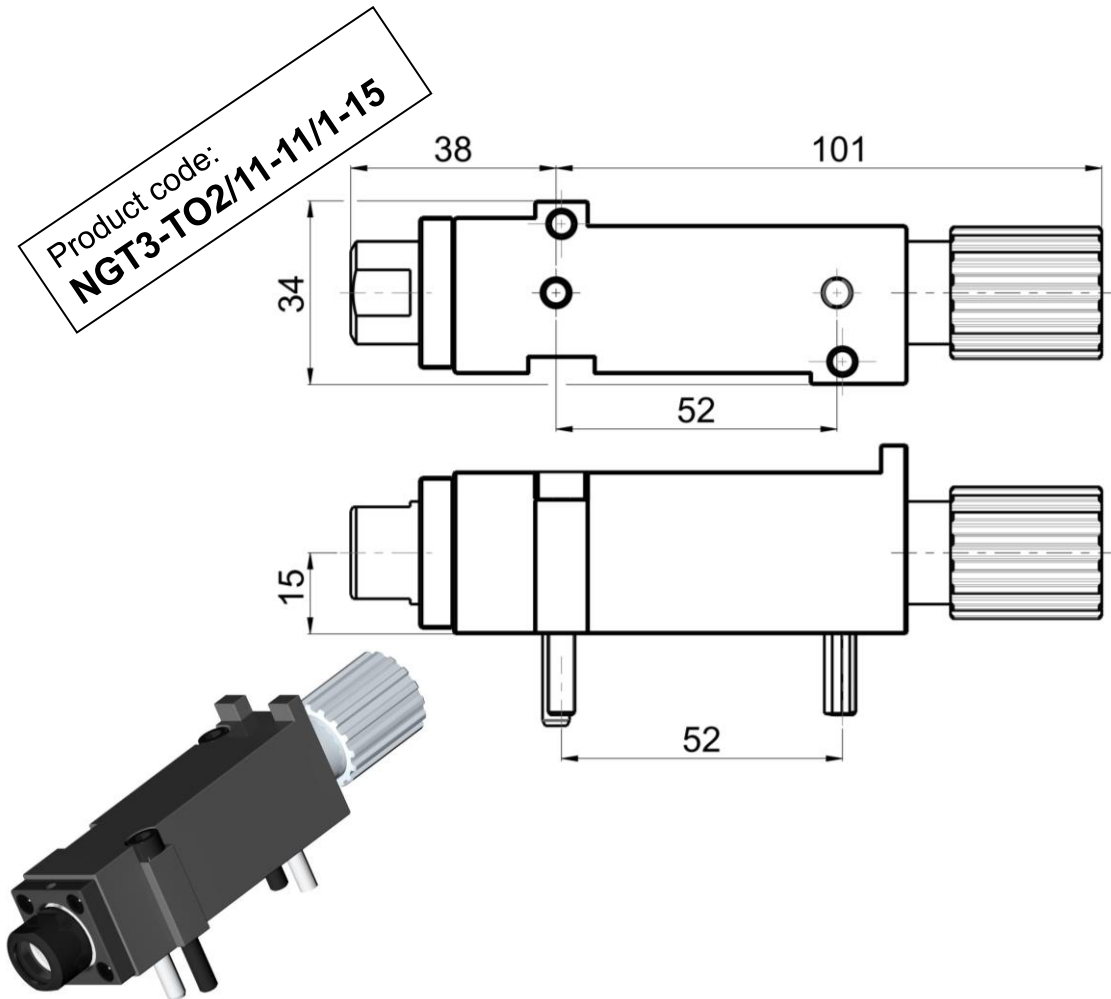

STRAIGHT LIVE TOOL HOLDER TORNOS

Product code:
NGT3-TO2/11-11/1-15



Max. speed: 12000 rpm

Collet: ER11 (HI-Q/ER; HI-Q/ERC)

Direction of rotation: ↻ ↻

Ratio: 1:1

Cooling: external

